

2024 List Price Book

Effective January 1, 2024

Jeffrey Alexander Vanities



JEFFREY ALEXANDER[®]
by Hardware Resources

Table of Contents

ORDERING MADE EASY p. 3

PART NUMBER KEYS p. 4

VANITIES

ASTORIA p. 5

CADE p. 6

CHATHAM p. 7-8

DASHWOOD p. 9

GARDNER p. 10

JUBILEE p. 11

KATARA p. 12

KIPLING p. 13

PASCAL p. 14

PERCIVAL p. 15

SAVINO p. 16

TEMPEST p. 17

THEODORA p. 18

WAVECREST p. 19

LEGS p. 20

TOPS

19" TOPS p. 21

25" TOPS p. 21

31" TOPS p. 22

37" TOPS - OVAL p. 23

37" TOPS - RECTANGLE p. 24

43" TOPS p. 25

49" TOPS p. 26

61" TOPS - SINGLE BOWL p. 27

61" TOPS - DOUBLE BOWL p. 28

SIDESPLASHES p. 29

BOWLS p. 29

WOOD FRAME MIRRORS p. 30-35

METAL FRAME MIRRORS p. 36

POLICIES AND PROCEDURES p. 37

Prices are subject to change

JEFFREY ALEXANDER[®]
by Hardware Resources

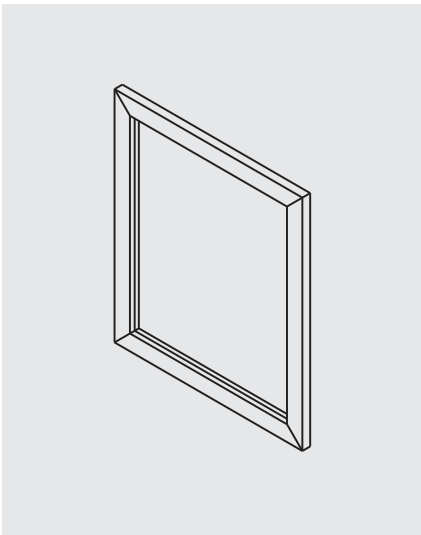
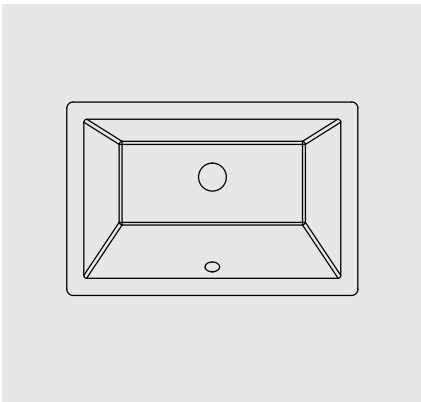
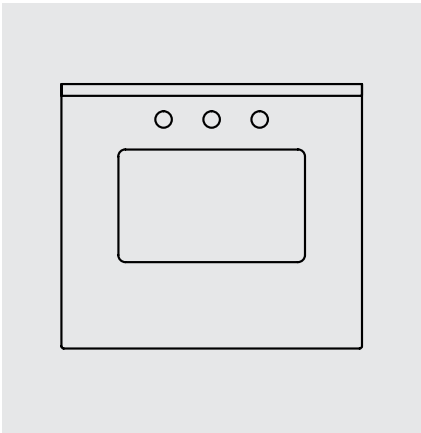

VANITY ORDERING MADE EASY



Dashwood Collection
Base: VN2DAS-24-NO-NT | Top: TOPR25CQ
Bowl: VN2-RECT-16 | Mirror: VMIR-METR-22MB

STEP 1

Select a vanity style

- Begin creating the ideal vanity by choosing from our many collections with a wide variety of sizes and trending finishes
- Pages 5–19



STEP 2

Select a vanity top color & material

- Choose from multiple different top colors in 3 types of material
- Matching backsplash included (except White Stone Resin)
- Pages 21–38

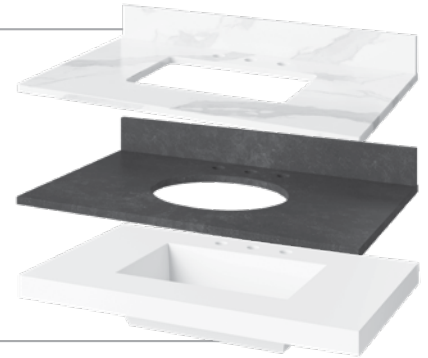

STEP 3

Select a bowl

- Choose a rectangle or oval bowl; available for most vanity tops (White Stone Resin and White Quartz are only available in rectangle)
- Page 29



STEP 4

Finish off the space

- Choose a coordinating mirror to create the ideal look
- Select optional legs (where applicable) to transform a floating vanity into a free-standing vanity
- Pages 30–36



COMPLETE THE LOOK

- Sidesplashes are available and will work on either side of the vanity top (see page 29)

- Check out our other product lines in the Designer Edition Catalog

Faucet not included with vanity purchase

PART NUMBER KEYS

VANITY BASE PART NUMBER KEY

Example (60" Grey Katara Vanity with No Top):

VN2KAT-60-GR-NT

designates 2nd generation vanity

designates the vanity collection

designates the width of the vanity in inches

designates the vanity finish

designates a vanity with no top

VANITY TOP PART NUMBER KEY

Example (49" Calacatta Vienna Quartz Top with Rectangle Bowl Cutout):

TOPR49CQ

designates part number is a vanity top

designates Rectangle (R) or Oval (O) bowl cutout

designates number to match the vanity width +1" (48" vanity + 1" = 49); tops create a 1/2" overhand on either side of the vanity

designates top material

MIRROR PART NUMBER KEY

Example (22" White Cade Mirror):

MIR2CAD-22-WH

designates 2nd generation vanity mirror

designates the primary coordinating vanity collection

designates the width of the mirror in inches

designates the mirror finish

SIDESPLASH PART NUMBER KEY

Example (21" Calacatta Vienna Quartz Sidesplash):

SSPLASH21CQ

designates part number is a sidesplash

Each sidesplash is 21" long and is universal for left or right side application

designates top material

CODE ABBREVIATIONS

COLLECTIONS

AST Astoria
CAD Cade
CHA Chatham
DAS Dashwood
GAR Gardner
JUB Jubilee
KAT Katara
KIP Kipling
PAS Pascal
PER Percival
SAV Savino
TEM Tempest
THE Theodora
WAV Wavecrest

VANITY WIDTHS

18 18" vanity
24 24" vanity
30 30" vanity
36 36" vanity
42 42" vanity
48 48" vanity
61 61" top (double bowl)
61S 61" top (single bowl)

TOP WIDTHS

19 19" top
25 25" top
31 31" top
37 37" top
43 43" top
49 49" top
61 61" top (double bowl)
61S 61" top (single bowl)

VANITY FINISHES

BK Black
BL Hale Blue
BS Blue Steel
CH Chocolate
DW Dark Walnut
ES Espresso
GN Forest Green
GR Grey
NO Natural Oak
WG Weathered Grey
WH White

TOP MATERIAL

AS Arctic Stone
BG Black Granite
BO Boulder
BQ Calacatta Black Quartz
CQ Calacatta Vienna Quartz
GQ Grey Quartz
LS Blue Limestone
MG Grey Marble
RE White Stone Resin
SG Steel Grey
WC White Carrara Marble
WQ White Quartz

Effective 1/1/2024

ASTORIA VANITIES*

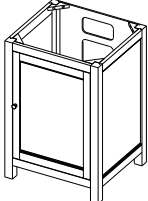
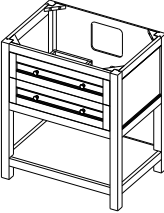
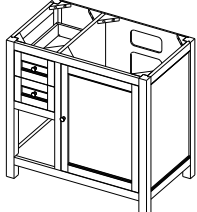
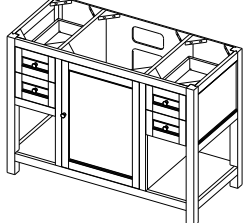
| | Size (width) | Configuration (width x depth x height) | Finish | | |
|---|-----------------|--|-----------------|-----------------|-----------------|
|  | 24" | Dimensions: 24" x 21-1/2" x 35" Bowl Position: Center Bowl Quantity: Single No Top | Espresso | Grey | White |
| | | | VN2AST-24-ES-NT | VN2AST-24-GR-NT | VN2AST-24-WH-NT |
| | | | \$1,220 | \$1,220 | \$1,220 |
|  | 30" | Dimensions: 30" x 21-1/2" x 35" Bowl Position: Center Bowl Quantity: Single No Top | Espresso | Grey | White |
| | | | VN2AST-30-ES-NT | VN2AST-30-GR-NT | VN2AST-30-WH-NT |
| | | | \$1,424 | \$1,424 | \$1,424 |
|  | 36" | Dimensions: 36" x 21-1/2" x 35" Bowl Position: Offset Right Bowl Quantity: Single No Top | Espresso | Grey | White |
| | | | VN2AST-36-ES-NT | VN2AST-36-GR-NT | VN2AST-36-WH-NT |
| | | | \$1,838 | \$1,838 | \$1,838 |
|  | 48" | Dimensions: 48" x 21-1/2" x 35" Bowl Position: Center Bowl Quantity: Single No Top | Espresso | Grey | White |
| | | | VN2AST-48-ES-NT | VN2AST-48-GR-NT | VN2AST-48-WH-NT |
| | | | \$2,560 | \$2,560 | \$2,560 |

The 36" vanity has a right offset bowl and requires a 37" top ending in AST

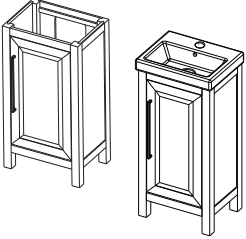
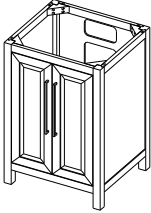
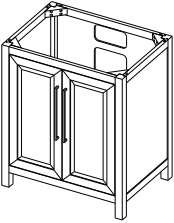
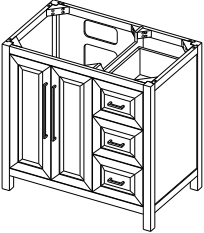
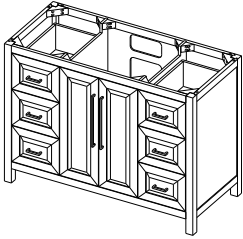
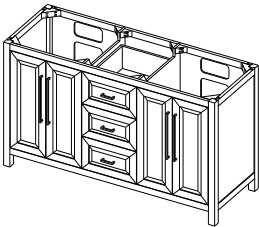

Effective 1/1/2024

CADE VANITIES

| | | Size (width) | Configuration (width x depth x height) | Finish | | | | |
|---|-----|--|---|--------------------|------------------|-------------------|--|--|
|  | 18" | w/o Top Dimensions: 18" x 13" x 33-1/2" w/ Top Dimensions: 17-3/8" x 13-1/2" x 36" Integrated Single Bowl | Grey (w/o top) | White (w/o top) | Grey (w/ top) | White (w/ top) | | |
| | | | VN2CAD-18-GR-NT* | VN2CAD-18-WH-NT* | VN2CAD-18-GR-PO | VN2CAD-18-WH-PO | | |
| | | | \$863 | \$863 | \$1,153 | \$1,153 | *Only 1 top option available: TOPR19RE-1 See page 22 | |
|  | 24" | Dimensions: 24" x 21-1/2" x 35" Bowl Position: Center Bowl Quantity: Single No Top | Black | Grey | White | | | |
| | | | VN2CAD-24-BK-NT | VN2CAD-24-GR-NT | VN2CAD-24-WH-NT | | | |
| | | | \$1,255 | \$1,255 | \$1,255 | | | |
|  | 30" | Dimensions: 30" x 21-1/2" x 35" Bowl Position: Center Bowl Quantity: Single No Top | Black | Grey | White | | | |
| | | | VN2CAD-30-BK-NT | VN2CAD-30-GR-NT | VN2CAD-30-WH-NT | | | |
| | | | \$1,491 | \$1,491 | \$1,491 | | | |
|  | 36" | Dimensions: 36" x 21-1/2" x 35" Bowl Position: Offset Left Bowl Quantity: Single No Top | Black | Grey | White | Hale Blue | Forest Green | |
| | | | VN2CAD-36-BK-NT | VN2CAD-36-GR-NT | VN2CAD-36-WH-NT | VN2CAD-36-BL-NT | VN2CAD-36-GN-NT | |
| | | | \$2,102 | \$2,102 | \$2,102 | \$2,102 | \$2,102 | |
|  | 48" | Dimensions: 48" x 21-1/2" x 35" Bowl Position: Center Bowl Quantity: Single No Top | Black | Grey | White | Hale Blue | | |
| | | | VN2CAD-48-BK-NT | VN2CAD-48-GR-NT | VN2CAD-48-WH-NT | VN2CAD-48-BL-NT | | |
| | | | \$2,790 | \$2,790 | \$2,790 | \$2,790 | | |
|  | 60" | Dimensions: 60" x 21-1/2" x 35" Bowl Position: Left & Right Bowl Quantity: Double No Top | Black | Grey | White | | | |
| | | | VN2CAD-60-BK-NT | VN2CAD-60-GR-NT | VN2CAD-60-WH-NT | | | |
| | | | \$3,347 | \$3,347 | \$3,347 | | | |

The 36" vanity has a left offset bowl and requires a 37" top ending in CAD-ADD

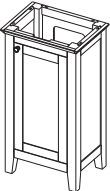
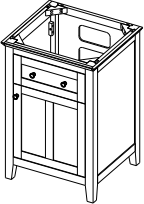
CHATHAM VANITIES

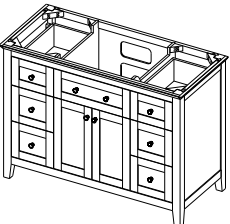

| | Size (width) | Configuration (width x depth x height) | Finish | | | | | |
|---|-----------------|---|---|------------------|------------------|-----------------|-----------------|--|
|  | 18" | Dimensions: 18" x 13" x 33-1/2" | Grey | White | Hale Blue | | | |
| | | Bowl Position: Center | VN2CHA-18-GR-NT* | VN2CHA-18-WH-NT* | VN2CHA-18-BL-NT* | | | |
| | | Bowl Quantity: Single | \$863 | \$863 | \$863 | | | |
| | | No Top | *Only 1 top option available: TOPR19RE-1 See page 22 | | | | | |
|  | 24" | Dimensions: 24" x 21-1/2" x 35" | Chocolate | Grey | White | Hale Blue | Blue Steel | |
| | | Bowl Position: Center | VN2CHA-24-CH-NT | VN2CHA-24-GR-NT | VN2CHA-24-WH-NT | VN2CHA-24-BL-NT | VN2CHA-24-BS-NT | |
| | | Bowl Quantity: Single | \$1,255 | \$1,255 | \$1,255 | \$1,255 | \$1,255 | |
| | | No Top | | | | | | |
|  | 30" | Dimensions: 30" x 21-1/2" x 35" | Chocolate | Grey | White | Hale Blue | Forest Green | |
| | | Bowl Position: Center | VN2CHA-30-CH-NT | VN2CHA-30-GR-NT | VN2CHA-30-WH-NT | VN2CHA-30-BL-NT | VN2CHA-30-GN-NT | |
| | | Bowl Quantity: Single | \$1,491 | \$1,491 | \$1,491 | \$1,491 | \$1,491 | |
| | | No Top | Blue Steel | | | | | |
| | | | VN2CHA-30-BS-NT | | | | | |
| | | \$1,491 | | | | | | |
|  | 36" | Dimensions: 36" x 21-1/2" x 35" | Chocolate | Grey | White | Hale Blue | Blue Steel | |
| | | Bowl Position: Center | VN2CHA-36-CH-NT | VN2CHA-36-GR-NT | VN2CHA-36-WH-NT | VN2CHA-36-BL-NT | VN2CHA-36-BS-NT | |
| | | Bowl Quantity: Single | \$1,898 | \$1,898 | \$1,898 | \$1,898 | \$1,898 | |
| | | No Top | | | | | | |
|  | 48" | Dimensions: 48" x 21-1/2" x 35" | Chocolate | Grey | White | Hale Blue | Blue Steel | |
| | | Bowl Position: Center | VN2CHA-48-CH-NT | VN2CHA-48-GR-NT | VN2CHA-48-WH-NT | VN2CHA-48-BL-NT | VN2CHA-48-BL-NT | |
| | | Bowl Quantity: Single | \$2,790 | \$2,790 | \$2,790 | \$2,790 | \$2,790 | |
| | | No Top | | | | | | |

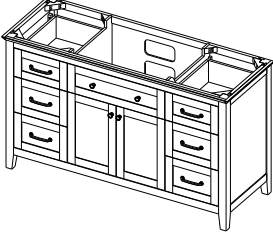
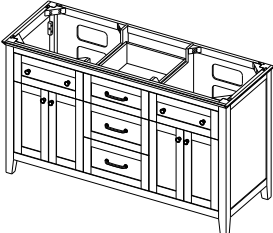
CHATHAM VANITIES - CONTINUED

| | Size (width) | Configuration (width x depth x height) | Finish | | |
|--|-----------------|---|-----------------|-----------------|-----------------|
|  | 60" | Dimensions: 60" x 21-1/2" x 35" | Chocolate | Grey | White |
| | | Bowl Position: Center | VN2CHA-60SCH-NT | VN2CHA-60SGR-NT | VN2CHA-60SWH-NT |
| | | Bowl Quantity: Single | \$3,610 | \$3,610 | \$3,610 |
| | | No Top | | | |
|  | 60" | Dimensions: 60" x 21-1/2" x 35" | Chocolate | Grey | White |
| | | Bowl Position: Left & Right | VN2CHA-60-CH-NT | VN2CHA-60-GR-NT | VN2CHA-60-WH-NT |
| | | Bowl Quantity: Double | \$3,347 | \$3,347 | \$3,347 |
| | | No Top | | | |

Effective 1/1/2024

DASHWOOD VANITIES

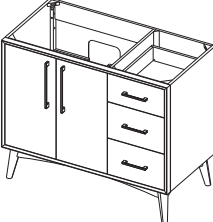
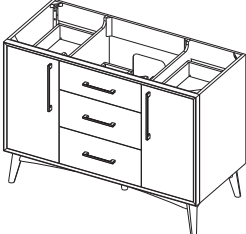
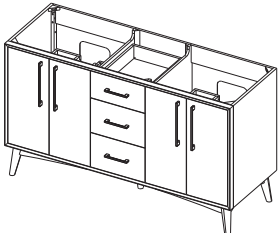
| | Size (width) | Configuration (width x depth x height) | Finish | | | |
|---|-----------------|---|-----------------|-----------------|-----------------|-------------|
|  | 24" | Dimensions: 24" x 21-1/2" x 35" | White | Dark Walnut | Natural Oak | |
| Bowl Position: Center | | VN2DAS-24-WH-NT | VN2DAS-24-DW-NT | VN2DAS-24-NO-NT | | |
| Bowl Quantity: Single | | \$1,363 | \$1,363 | \$1,363 | | |
| | | No Top | | | | |
|  | 30" | Dimensions: 30" x 21-1/2" x 35" | White | Blue Steel | Dark Walnut | Natural Oak |
| Bowl Position: Center | | VN2DAS-30-WH-NT | VN2DAS-30-BS-NT | VN2DAS-30-DW-NT | VN2DAS-30-NO-NT | |
| Bowl Quantity: Single | | \$1,506 | \$1,506 | \$1,506 | \$1,506 | |
| | | No Top | | | | |
|  | 36" | Dimensions: 36" x 21-1/2" x 35" | White | Blue Steel | Dark Walnut | Natural Oak |
| Bowl Position: Offset Left | | VN2DAS-36-WH-NT | VN2DAS-36-BS-NT | VN2DAS-36-DW-NT | VN2DAS-36-NO-NT | |
| Bowl Quantity: Single | | \$2,137 | \$2,137 | \$2,137 | \$2,137 | |
| | | No Top | | | | |
|  | 42" | Dimensions: 42" x 21-1/2" x 35" | White | Dark Walnut | Natural Oak | |
| Bowl Position: Offset Left | | VN2DAS-42-WH-NT | VN2DAS-42-DW-NT | VN2DAS-42-NO-NT | | |
| Bowl Quantity: Single | | \$2,363 | \$2,363 | \$2,363 | | |
| | | No Top | | | | |
|  | 48" | Dimensions: 48" x 21-1/2" x 35" | White | Blue Steel | Dark Walnut | Natural Oak |
| Bowl Position: Center | | VN2DAS-48-WH-NT | VN2DAS-48-BS-NT | VN2DAS-48-DW-NT | VN2DAS-48-NO-NT | |
| Bowl Quantity: Single | | \$2,834 | \$2,834 | \$2,834 | \$2,834 | |
| | | No Top | | | | |
|  | 60" | Dimensions: 60" x 21-1/2" x 35" | White | Dark Walnut | Natural Oak | |
| Bowl Position: Left & Right | | VN2DAS-60-WH-NT | VN2DAS-60-DW-NT | VN2DAS-60-NO-NT | | |
| Bowl Quantity: Double | | \$3,600 | \$3,600 | \$3,600 | | |
| | | No Top | | | | |

The 36" vanity has a left offset bowl and requires a 37" top ending in CAD-ADD. The 42" vanity has a left offset bowl and requires a 43" top ending in LFT.

GARDNER VANITIES

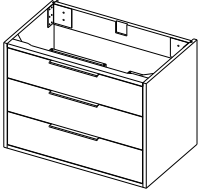
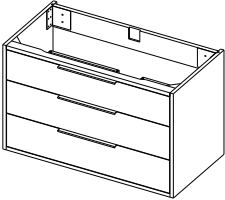
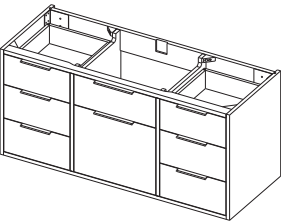

| | Size <i>(width)</i> | Configuration <i>(width x depth x height)</i> | Finish | | | |
|---|------------------------|--|-----------------|-----------------|-----------------|-------|
|  | 30" | Dimensions: 30" x 18-1/2" x 22" Bowl Position: Center Bowl Quantity: Single No Top | Blue Steel | Dark Walnut | Natural Oak | White |
| | | VN2GAR-30-BS-NT | VN2GAR-30-DW-NT | VN2GAR-30-NO-NT | VN2GAR-30-WH-NT | |
| | | \$1,292 | \$1,292 | \$1,292 | \$1,292 | |
|  | 36" | Dimensions: 36" x 18-1/2" x 22" Bowl Position: Center Bowl Quantity: Single No Top | Blue Steel | Dark Walnut | Natural Oak | White |
| | | VN2GAR-36-BS-NT | VN2GAR-36-DW-NT | VN2GAR-36-NO-NT | VN2GAR-36-WH-NT | |
| | | \$1,430 | \$1,430 | \$1,430 | \$1,430 | |
|  | 48" | Dimensions: 48" x 18-1/2" x 22" Bowl Position: Center Bowl Quantity: Single No Top | Blue Steel | Dark Walnut | Natural Oak | White |
| | | VN2GAR-48-BS-NT | VN2GAR-48-DW-NT | VN2GAR-48-NO-NT | VN2GAR-48-WH-NT | |
| | | \$2,456 | \$2,456 | \$2,456 | \$2,456 | |

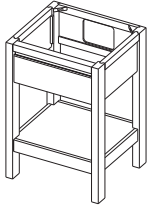
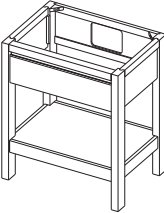
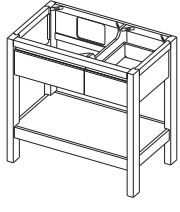
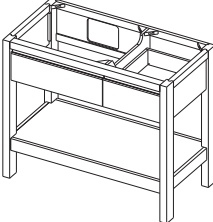
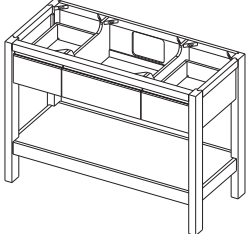
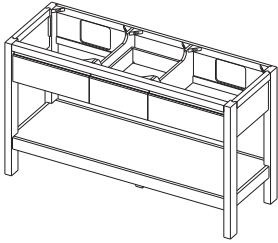
JUBILEE VANITIES

| | Size (width) | Configuration (width x depth x height) | Finish | | | | |
|---|-----------------|---|-----------------|-----------------|-----------------|-----------------|-----------------|
|  | 24" | Dimensions: 24" x 21-1/2" x 35" | Grey | White | Weathered Grey | Dark Walnut | Natural Oak |
| | | Bowl Position: Center | VN2JUB-24-GR-NT | VN2JUB-24-WH-NT | VN2JUB-24-WG-NT | VN2JUB-24-DW-NT | VN2JUB-24-NO-NT |
| | | Bowl Quantity: Single No Top | \$1,180 | \$1,180 | \$1,180 | \$1,180 | \$1,180 |
|  | 30" | Dimensions: 30" x 21-1/2" x 35" | Grey | White | Weathered Grey | Dark Walnut | Natural Oak |
| | | Bowl Position: Center | VN2JUB-30-GR-NT | VN2JUB-30-WH-NT | VN2JUB-30-WG-NT | VN2JUB-30-DW-NT | VN2JUB-30-NO-NT |
| | | Bowl Quantity: Single No Top | \$1,343 | \$1,343 | \$1,343 | \$1,343 | \$1,343 |
|  | 36" | Dimensions: 36" x 21-1/2" x 35" | Grey | White | Weathered Grey | Dark Walnut | Natural Oak |
| | | Bowl Position: Offset Left | VN2JUB-36-GR-NT | VN2JUB-36-WH-NT | VN2JUB-36-WG-NT | VN2JUB-36-DW-NT | VN2JUB-36-NO-NT |
| | | Bowl Quantity: Single No Top | \$1,681 | \$1,681 | \$1,681 | \$1,681 | \$1,681 |
|  | 42" | Dimensions: 42" x 21-1/2" x 35" | Grey | White | Weathered Grey | Dark Walnut | Natural Oak |
| | | Bowl Position: Offset Left | VN2JUB-42-GR-NT | VN2JUB-42-WH-NT | VN2JUB-42-WG-NT | VN2JUB-42-DW-NT | VN2JUB-42-NO-NT |
| | | Bowl Quantity: Single No Top | \$1,821 | \$1,821 | \$1,821 | \$1,821 | \$1,821 |
|  | 48" | Dimensions: 48" x 21-1/2" x 35" | Grey | White | Weathered Grey | Dark Walnut | Natural Oak |
| | | Bowl Position: Center | VN2JUB-48-GR-NT | VN2JUB-48-WH-NT | VN2JUB-48-WG-NT | VN2JUB-48-DW-NT | VN2JUB-48-NO-NT |
| | | Bowl Quantity: Single No Top | \$2,202 | \$2,202 | \$2,202 | \$2,202 | \$2,202 |
|  | 60" | Dimensions: 60" x 21-1/2" x 35" | Grey | White | Weathered Grey | Dark Walnut | Natural Oak |
| | | Bowl Position: Left & Right | VN2JUB-60-GR-NT | VN2JUB-60-WH-NT | VN2JUB-60-WG-NT | VN2JUB-60-DW-NT | VN2JUB-48-NO-NT |
| | | Bowl Quantity: Double No Top | \$2,388 | \$2,388 | \$2,388 | \$2,388 | \$2,388 |

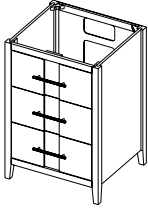

The 36" vanity has a left offset bowl and requires a 37" top ending in CAD-ADD. The 42" vanity has a left offset bowl and requires a 43" top ending in LFT.

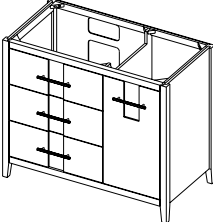
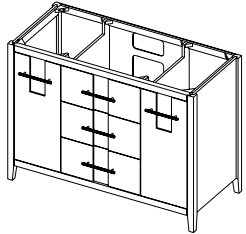
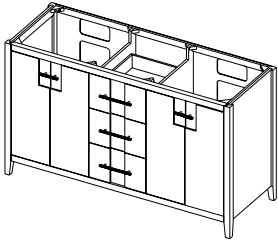
KATARA VANITIES

| | Size (width) | Configuration (width x depth x height) | Finish | | | | | |
|---|-----------------|---|-----------------|-----------------|-----------------|-----------------|-----------------|------------|
|  | 24" | Dimensions: 24" x 21-1/2" x 35" | Black | Grey | White | Hale Blue | | |
| Bowl Position: Center | | VN2KAT-24-BK-NT | VN2KAT-24-GR-NT | VN2KAT-24-WH-NT | VN2KAT-24-BL-NT | | | |
| Bowl Quantity: Single | | \$1,426 | \$1,426 | \$1,426 | \$1,426 | | | |
| | | No Top | | | | | | |
|  | 30" | Dimensions: 30" x 21-1/2" x 35" | Black | Grey | White | Hale Blue | Forest Green | Blue Steel |
| Bowl Position: Center | | VN2KAT-30-BK-NT | VN2KAT-30-GR-NT | VN2KAT-30-WH-NT | VN2KAT-30-BL-NT | VN2KAT-30-GN-NT | VN2KAT-30-BS-NT | |
| Bowl Quantity: Single | | \$1,624 | \$1,624 | \$1,624 | \$1,624 | \$1,624 | \$1,624 | |
| | | No Top | | | | | | |
|  | 36" | Dimensions: 36" x 21-1/2" x 35" | Black | Grey | White | Hale Blue | Forest Green | Blue Steel |
| Bowl Position: Offset Left | | VN2KAT-36-BK-NT | VN2KAT-36-GR-NT | VN2KAT-36-WH-NT | VN2KAT-36-BL-NT | VN2KAT-36-GN-NT | VN2KAT-36-BS-NT | |
| Bowl Quantity: Single | | \$2,157 | \$2,157 | \$2,157 | \$2,157 | \$2,157 | \$2,157 | |
| | | No Top | | | | | | |
|  | 42" | Dimensions: 42" x 21-1/2" x 35" | Black | Grey | White | Hale Blue | Forest Green | Blue Steel |
| Bowl Position: Offset Left | | VN2KAT-42-BK-NT | VN2KAT-42-GR-NT | VN2KAT-42-WH-NT | VN2KAT-42-BL-NT | VN2KAT-42-GN-NT | VN2KAT-42-BS-NT | |
| Bowl Quantity: Single | | \$2,277 | \$2,277 | \$2,277 | \$2,277 | \$2,277 | \$2,277 | |
| | | No Top | | | | | | |
|  | 48" | Dimensions: 48" x 21-1/2" x 35" | Black | Grey | White | Hale Blue | Forest Green | Blue Steel |
| Bowl Position: Center | | VN2KAT-48-BK-NT | VN2KAT-48-GR-NT | VN2KAT-48-WH-NT | VN2KAT-48-BL-NT | VN2KAT-48-GN-NT | VN2KAT-48-BS-NT | |
| Bowl Quantity: Single | | \$2,951 | \$2,951 | \$2,951 | \$2,951 | \$2,951 | \$2,951 | |
| | | No Top | | | | | | |
|  | 60" | Dimensions: 60" x 21-1/2" x 35" | Black | Grey | White | Hale Blue | | |
| Bowl Position: Left & Right | | VN2KAT-60-BK-NT | VN2KAT-60-GR-NT | VN2KAT-60-WH-NT | VN2KAT-60-BL-NT | | | |
| Bowl Quantity: Double | | \$3,583 | \$3,583 | \$3,583 | \$3,583 | | | |
| | | No Top | | | | | | |

The 36" vanity has a left offset bowl and requires a 37" top ending in CAD-ADD. The 42" vanity has a left offset bowl and requires a 43" top ending in LFT.

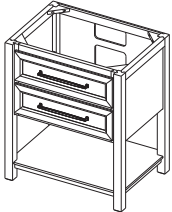
KIPLING VANITIES

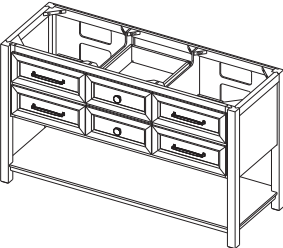
| | Size <i>(width)</i> | Configuration <i>(width x depth x height)</i> | Finish | | | |
|--|------------------------|--|-----------------|--------------------|--------------------|-----------------|
|  | 30" | Dimensions: 30" x 21-1/2" x 35" | Black | Dark Walnut | Natural Oak | White |
| | | Bowl Position: Center | VN2KIP-30-BK-NT | VN2KIP-30-DW-NT | VN2KIP-30-NO-NT | VN2KIP-30-WH-NT |
| | | Bowl Quantity: Single | \$1,284 | \$1,284 | \$1,284 | \$1,284 |
| | | No Top | | | | |
|  | 36" | Dimensions: 36" x 21-1/2" x 35" | Black | Dark Walnut | Natural Oak | White |
| | | Bowl Position: Center | VN2KIP-36-BK-NT | VN2KIP-36-DW-NT | VN2KIP-36-NO-NT | VN2KIP-36-WH-NT |
| | | Bowl Quantity: Single | \$1,384 | \$1,384 | \$1,384 | \$1,384 |
| | | No Top | | | | |
|  | 48" | Dimensions: 48" x 21-1/2" x 35" | Black | Dark Walnut | Natural Oak | White |
| | | Bowl Position: Center | VN2KIP-48-BK-NT | VN2KIP-48-DW-NT | VN2KIP-48-NO-NT | VN2KIP-48-WH-NT |
| | | Bowl Quantity: Single | \$1,697 | \$1,697 | \$1,697 | \$1,697 |
| | | No Top | | | | |
|  | 60" | Dimensions: 60" x 21-1/2" x 35" | Black | Dark Walnut | Natural Oak | White |
| | | Bowl Position: Left & Right | VN2KIP-60-BK-NT | VN2KIP-60-DW-NT | VN2KIP-60-NO-NT | VN2KIP-60-WH-NT |
| | | Bowl Quantity: Double | \$2,405 | \$2,405 | \$2,405 | \$2,405 |
| | | No Top | | | | |

Effective 1/1/2024

PASCAL VANITIES

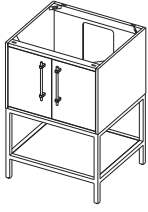
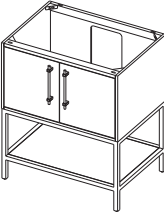
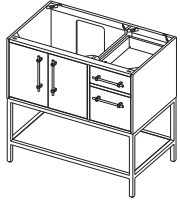
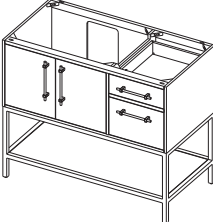
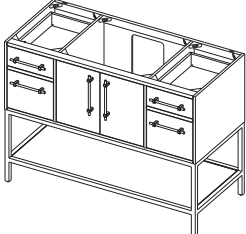
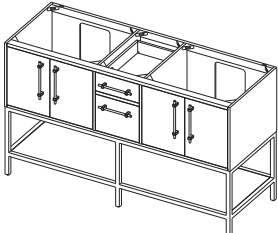
| | Size (width) | Configuration (width x depth x height) | Finish | | | | | |
|---|-----------------|---|-----------------|-----------------|-----------------|-----------------|-----------------|-----------------|
|  | 24" | Dimensions: 24" x 21-1/2" x 35" | Grey | White | Blue Steel | Weathered Grey | Dark Walnut | Natural Oak |
| | | Bowl Position: Center | VN2PAS-24-GR-NT | VN2PAS-24-WH-NT | VN2PAS-24-BS-NT | VN2PAS-24-WG-NT | VN2PAS-24-DW-NT | VN2PAS-24-NO-NT |
| | | Bowl Quantity: Single No Top | \$1,337 | \$1,337 | \$1,337 | \$1,337 | \$1,337 | \$1,337 |
|  | 30" | Dimensions: 30" x 21-1/2" x 35" | Grey | White | Blue Steel | Weathered Grey | Dark Walnut | Natural Oak |
| | | Bowl Position: Center | VN2PAS-30-GR-NT | VN2PAS-30-WH-NT | VN2PAS-30-BS-NT | VN2PAS-30-WG-NT | VN2PAS-30-DW-NT | VN2PAS-30-NO-NT |
| | | Bowl Quantity: Single No Top | \$1,524 | \$1,524 | \$1,524 | \$1,524 | \$1,524 | \$1,524 |
|  | 36" | Dimensions: 36" x 21-1/2" x 35" | Grey | White | Blue Steel | Weathered Grey | Dark Walnut | Natural Oak |
| | | Bowl Position: Offset Left | VN2PAS-36-GR-NT | VN2PAS-36-WH-NT | VN2PAS-36-BS-NT | VN2PAS-36-WG-NT | VN2PAS-36-DW-NT | VN2PAS-36-NO-NT |
| | | Bowl Quantity: Single No Top | \$1,976 | \$1,976 | \$1,976 | \$1,976 | \$1,976 | \$1,976 |
|  | 42" | Dimensions: 42" x 21-1/2" x 35" | Grey | White | Dark Walnut | Natural Oak | | |
| | | Bowl Position: Offset Left | VN2PAS-42-GR-NT | VN2PAS-42-WH-NT | VN2PAS-42-DW-NT | VN2PAS-42-NO-NT | | |
| | | Bowl Quantity: Single No Top | \$2,210 | \$2,210 | \$2,210 | \$2,210 | | |
|  | 48" | Dimensions: 48" x 21-1/2" x 35" | Grey | White | Blue Steel | Weathered Grey | Dark Walnut | Natural Oak |
| | | Bowl Position: Center | VN2PAS-48-GR-NT | VN2PAS-48-WH-NT | VN2PAS-48-BS-NT | VN2PAS-48-WG-NT | VN2PAS-48-DW-NT | VN2PAS-48-NO-NT |
| | | Bowl Quantity: Single No Top | \$2,809 | \$2,809 | \$2,809 | \$2,809 | \$2,809 | \$2,809 |
|  | 60" | Dimensions: 60" x 21-1/2" x 35" | Grey | White | Weathered Grey | Dark Walnut | Natural Oak | |
| | | Bowl Position: Left & Right | VN2PAS-60-GR-NT | VN2PAS-60-WH-NT | VN2PAS-60-WG-NT | VN2PAS-60-DW-NT | VN2PAS-60-NO-NT | |
| | | Bowl Quantity: Double No Top | \$3,028 | \$3,028 | \$3,028 | \$3,028 | \$3,028 | |

The 36" vanity has a left offset bowl and requires a 37" top ending in CAD-ADD. The 42" vanity has a left offset bowl and requires a 43" top ending in LFT.

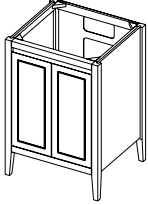
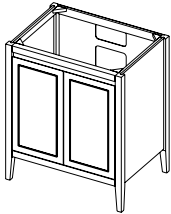
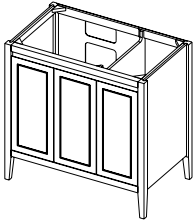

PERCIVAL VANITIES

| | Size <i>(width)</i> | Configuration <i>(width x depth x height)</i> | Finish | | | |
|--|------------------------|--|-----------------|-----------------|-----------------|------------------|
|  | 24" | Dimensions: 24" x 21-1/2" x 35" | Black | Grey | White | Hale Blue |
| | | Bowl Position: Center | VN2PER-24-BK-NT | VN2PER-24-GR-NT | VN2PER-24-WH-NT | VN2PER-24-BL-NT |
| | | Bowl Quantity: Single | \$1,334 | \$1,334 | \$1,334 | \$1,334 |
| | | No Top | | | | |
|  | 30" | Dimensions: 30" x 21-1/2" x 35" | Black | Grey | White | Hale Blue |
| | | Bowl Position: Center | VN2PER-30-BK-NT | VN2PER-30-GR-NT | VN2PER-30-WH-NT | VN2PER-30-BL-NT |
| | | Bowl Quantity: Single | \$1,584 | \$1,584 | \$1,584 | \$1,584 |
| | | No Top | | | | |
|  | 36" | Dimensions: 36" x 21-1/2" x 35" | Black | Grey | White | Hale Blue |
| | | Bowl Position: Offset Left | VN2PER-36-BK-NT | VN2PER-36-GR-NT | VN2PER-36-WH-NT | VN2PER-36-BL-NT |
| | | Bowl Quantity: Single | \$2,144 | \$2,144 | \$2,144 | \$2,144 |
| | | No Top | | | | |

The 36" vanity has a left offset bowl and requires a 37" top ending in CAD-ADD

Effective 1/1/2024

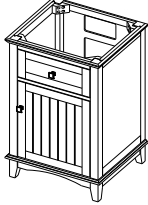
SAVINO VANITIES*

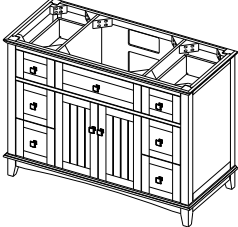
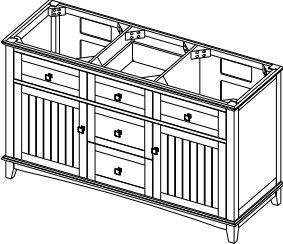
| | Size (width) | Configuration (width x depth x height) | Finish | |
|---|-----------------|--|-----------------|-----------------|
|  | 24" | Dimensions: 24" x 21-1/2" x 35" Bowl Position: Center Bowl Quantity: Single No Top | Grey | White |
| | | | VN2SAV-24-GR-NT | VN2SAV-24-WH-NT |
| | | | \$1,288 | \$1,288 |
|  | 30" | Dimensions: 30" x 21-1/2" x 35" Bowl Position: Center Bowl Quantity: Single No Top | Grey | White |
| | | | VN2SAV-30-GR-NT | VN2SAV-30-WH-NT |
| | | | \$1,696 | \$1,696 |
|  | 36" | Dimensions: 36" x 21-1/2" x 35" Bowl Position: Center Bowl Quantity: Single No Top | Grey | White |
| | | | VN2SAV-36-GR-NT | VN2SAV-36-WH-NT |
| | | | \$2,238 | \$2,238 |
|  | 48" | Dimensions: 48" x 21-1/2" x 35" Bowl Position: Center Bowl Quantity: Single No Top | Grey | White |
| | | | VN2SAV-48-GR-NT | VN2SAV-48-WH-NT |
| | | | \$2,955 | \$2,955 |
|  | 60" | Dimensions: 60" x 21-1/2" x 35" Bowl Position: Left & Right Bowl Quantity: Double No Top | Grey | White |
| | | | VN2SAV-60-GR-NT | VN2SAV-60-WH-NT |
| | | | \$3,478 | \$3,478 |

TEMPEST VANITIES

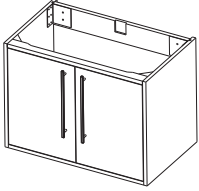
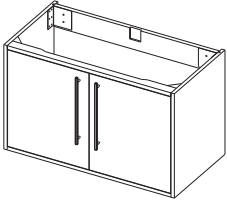
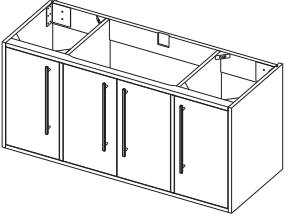
| | Size <i>(width)</i> | Configuration <i>(width x depth x height)</i> | Finish | | | |
|---|------------------------|--|-----------------|-----------------|-----------------|-----------------|
|  | 30" | Dimensions: 30" x 18-1/2" x 22" | Blue Steel | Dark Walnut | Natural Oak | White |
| | | Bowl Position: Center | VN2TEM-30-BS-NT | VN2TEM-30-DW-NT | VN2TEM-30-NO-NT | VN2TEM-30-WH-NT |
| | | Bowl Quantity: Single | \$1,253 | \$1,253 | \$1,253 | \$1,253 |
| | | No Top | | | | |
|  | 36" | Dimensions: 36" x 18-1/2" x 22" | Blue Steel | Dark Walnut | Natural Oak | White |
| | | Bowl Position: Center | VN2TEM-36-BS-NT | VN2TEM-36-DW-NT | VN2TEM-36-NO-NT | VN2TEM-36-WH-NT |
| | | Bowl Quantity: Single | \$1,376 | \$1,376 | \$1,376 | \$1,376 |
| | | No Top | | | | |
|  | 48" | Dimensions: 48" x 18-1/2" x 22" | Blue Steel | Dark Walnut | Natural Oak | White |
| | | Bowl Position: Center | VN2TEM-48-BS-NT | VN2TEM-48-DW-NT | VN2TEM-48-NO-NT | VN2TEM-48-WH-NT |
| | | Bowl Quantity: Single | \$2,198 | \$2,198 | \$2,198 | \$2,198 |
| | | No Top | | | | |

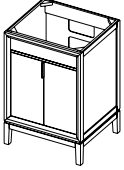
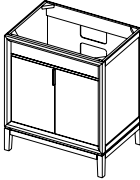
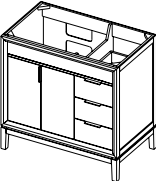
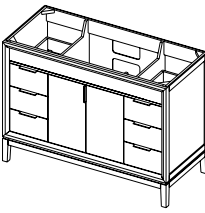
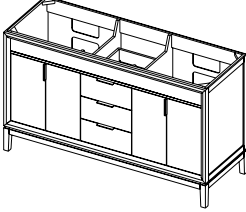

THEODORA VANITIES

| | Size (width) | Configuration (width x depth x height) | Finish | | | | | |
|---|-----------------|---|-----------------|-----------------|-----------------|------------------|-------------------|---------------------|
|  | 24" | Dimensions: 24" x 21-1/2" x 35" | Black | Grey | White | Hale Blue | Blue Steel | |
| | | Bowl Position: Center | VN2THE-24-BK-NT | VN2THE-24-GR-NT | VN2THE-24-WH-NT | VN2THE-24-BL-NT | VN2THE-24-BS-NT | |
| | | Bowl Quantity: Single No Top | \$1,341 | \$1,341 | \$1,341 | \$1,341 | \$1,341 | |
|  | 30" | Dimensions: 30" x 21-1/2" x 35" | Black | Grey | White | Hale Blue | Blue Steel | Forest Green |
| | | Bowl Position: Center | VN2THE-30-BK-NT | VN2THE-30-GR-NT | VN2THE-30-WH-NT | VN2THE-30-BL-NT | VN2THE-30-BS-NT | VN2THE-30-GN-NT |
| | | Bowl Quantity: Single No Top | \$1,575 | \$1,575 | \$1,575 | \$1,575 | \$1,575 | \$1,575 |
|  | 36" | Dimensions: 36" x 21-1/2" x 35" | Black | Grey | White | Hale Blue | Blue Steel | Forest Green |
| | | Bowl Position: Offset Left | VN2THE-36-BK-NT | VN2THE-36-GR-NT | VN2THE-36-WH-NT | VN2THE-36-BL-NT | VN2THE-36-BS-NT | VN2THE-36-GN-NT |
| | | Bowl Quantity: Single No Top | \$2,170 | \$2,170 | \$2,170 | \$2,170 | \$2,170 | \$2,170 |
|  | 48" | Dimensions: 48" x 21-1/2" x 35" | Black | Grey | White | Hale Blue | Blue Steel | Forest Green |
| | | Bowl Position: Center | VN2THE-48-BK-NT | VN2THE-48-GR-NT | VN2THE-48-WH-NT | VN2THE-48-BL-NT | VN2THE-48-BS-NT | VN2THE-48-GN-NT |
| | | Bowl Quantity: Single No Top | \$2,818 | \$2,818 | \$2,818 | \$2,818 | \$2,818 | \$2,818 |
|  | 60" | Dimensions: 60" x 21-1/2" x 35" | Black | Grey | White | Hale Blue | Blue Steel | |
| | | Bowl Position: Left & Right | VN2THE-60-BK-NT | VN2THE-60-GR-NT | VN2THE-60-WH-NT | VN2THE-60-BL-NT | VN2THE-60-BS-NT | |
| | | Bowl Quantity: Double No Top | \$3,387 | \$3,387 | \$3,387 | \$3,387 | \$3,387 | |

The 36" vanity has a left offset bowl and requires a 37" top ending in CAD-ADD

Effective 1/1/2024

WAVECREST VANITIES

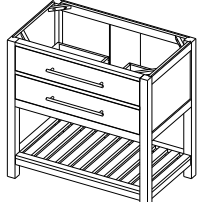
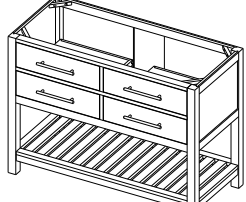
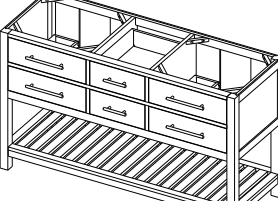
| | Size (width) | Configuration (width x depth x height) | Finish | | | | |
|---|-----------------|---|-----------------|-----------------|-----------------|-----------------|-----------------|
|  | 24" | Dimensions: 24" x 21-1/2" x 35" | Grey | White | Weathered Grey | | |
| | | Bowl Position: Center | VN2WAV-24-GR-NT | VN2WAV-24-WH-NT | VN2WAV-24-WG-NT | | |
| | | Bowl Quantity: Single | \$1,220 | \$1,220 | \$1,220 | | |
| | | No Top | | | | | |
|  | 30" | Dimensions: 30" x 21-1/2" x 35" | Grey | White | Hale Blue | Forest Green | Weathered Grey |
| | | Bowl Position: Center | VN2WAV-30-GR-NT | VN2WAV-30-WH-NT | VN2WAV-30-BL-NT | VN2WAV-30-GN-NT | VN2WAV-30-WG-NT |
| | | Bowl Quantity: Single | \$1,424 | \$1,424 | \$1,424 | \$1,424 | \$1,424 |
| | | No Top | | | | | |
|  | 36" | Dimensions: 36" x 21-1/2" x 35" | Grey | White | Hale Blue | Forest Green | Weathered Grey |
| | | Bowl Position: Center | VN2WAV-36-GR-NT | VN2WAV-36-WH-NT | VN2WAV-36-BL-NT | VN2WAV-36-GN-NT | VN2WAV-36-WG-NT |
| | | Bowl Quantity: Single | \$1,772 | \$1,772 | \$1,772 | \$1,772 | \$1,772 |
| | | No Top | | | | | |
|  | 48" | Dimensions: 48" x 21-1/2" x 35" | Grey | White | Hale Blue | Forest Green | Weathered Grey |
| | | Bowl Position: Center | VN2WAV-48-GR-NT | VN2WAV-48-WH-NT | VN2WAV-48-BL-NT | VN2WAV-48-GN-NT | VN2WAV-48-WG-NT |
| | | Bowl Quantity: Single | \$2,505 | \$2,505 | \$2,505 | \$2,505 | \$2,505 |
| | | No Top | | | | | |
|  | 60" | Dimensions: 60" x 21-1/2" x 35" | Grey | White | Weathered Grey | | |
| | | Bowl Position: Left & Right | VN2WAV-60-GR-NT | VN2WAV-60-WH-NT | VN2WAV-60-WG-NT | | |
| | | Bowl Quantity: Double | \$3,147 | \$3,147 | \$3,147 | | |
| | | No Top | | | | | |

Prices are subject to change

LEGS

Fits Gardner and Tempest floating vanities.

| Type | Item # | Finish | Vanity Size | List Price |
|----------------------------|-------------|-------------|-------------|------------|
| METAL PENCIL LEGS | VNLEGPEN4 | Matte Black | 30" & 36" | \$133 |
| | VNLEGPEN5 | Matte Black | 48" | \$155 |
| SQUARE STEEL FRAME LEGS | VNLEGSQ30 | Matte Black | 30" | \$251 |
| | VNLEGSQ36 | Matte Black | 36" | \$283 |
| | VNLEGSQ48 | Matte Black | 48" | \$335 |
| WOOD FRAME LEGS | VNLEGWD30WH | White | 30" | \$376 |
| | VNLEGWD36WH | White | 36" | \$445 |
| | VNLEGWD48WH | White | 48" | \$514 |
| | VNLEGWD30BS | Blue Steel | 30" | \$376 |
| | VNLEGWD36BS | Blue Steel | 36" | \$445 |
| | VNLEGWD48BS | Blue Steel | 48" | \$514 |
| | VNLEGWD30DW | Dark Walnut | 30" | \$376 |
| | VNLEGWD36DW | Dark Walnut | 36" | \$445 |
| | VNLEGWD48DW | Dark Walnut | 48" | \$514 |
| | VNLEGWD30NO | Natural Oak | 30" | \$376 |
| | VNLEGWD36NO | Natural Oak | 36" | \$445 |
| VNLEGWD48NO | Natural Oak | 48" | \$514 | |

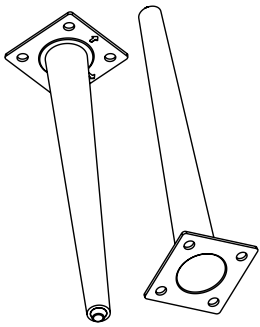

VNLEGPEN4/VNLEGPEN5

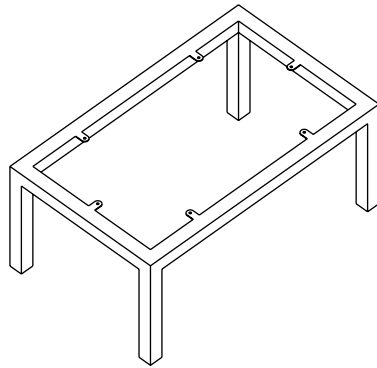

VNLEGSQ30/36/48

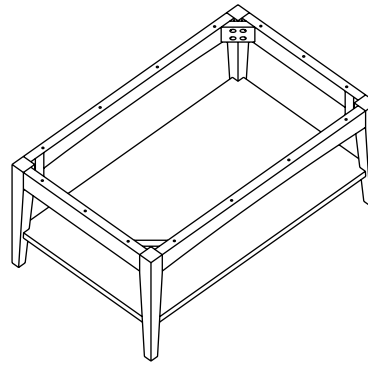

VNLEGWD30/36/48xx

19" TOPS

| Size | Item # | Material (Engineered) | Thickness | Bowl Shape | Bowl Layout | Faucet Layout | List Price |
|------|------------|-----------------------|-----------|------------|----------------------------|---------------|------------|
| 19" | TOPR19RE-1 | White Stone Resin | 64 mm | Rectangle | Single, Center, Integrated | 1-hole | \$284.00 |

Coordinating mirrors (pages 30-36) are available.

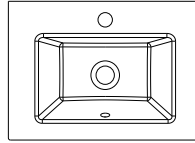

TOPR19RE-1
(integrated bowl)

25" TOPS

| Size | Item # | Material | Thickness | Bowl Shape | Bowl Layout | Faucet Layout | List Price | | |
|-----------|------------|----------------------|-------------------------|---------------|----------------|----------------------------|----------------|---------|-------|
| 25" | TOPO25BQ* | QUARTZ | Calacatta Black Quartz | 18 mm | Oval | Single, Center | 3-hole | \$1,272 | |
| | TOPR25BQ* | | Calacatta Black Quartz | 18 mm | Rectangle | Single, Center | 3-hole | \$1,272 | |
| | TOPO25CQ | | Calacatta Vienna Quartz | 18 mm | Oval | Single, Center | 3-hole | \$1,227 | |
| | TOPR25CQ | | Calacatta Vienna Quartz | 18 mm | Rectangle | Single, Center | 3-hole | \$1,227 | |
| | TOPO25GQ | | Grey Quartz | 18 mm | Oval | Single, Center | 3-hole | \$637 | |
| | TOPR25GQ | | Grey Quartz | 18 mm | Rectangle | Single, Center | 3-hole | \$637 | |
| | TOPR25WQ | | White Quartz | 18 mm | Rectangle | Single, Center | 3-hole | \$765 | |
| | TOPR25WQ-1 | | White Quartz | 18 mm | Rectangle | Single, Center | 1-hole | \$765 | |
| | TOPO25BG | | NATURAL STONE | Black Granite | 25 mm | Oval | Single, Center | 3-hole | \$596 |
| | TOPR25BG | | | Black Granite | 25 mm | Rectangle | Single, Center | 3-hole | \$596 |
| | TOPO25LS | Blue Limestone | | 25 mm | Oval | Single, Center | 3-hole | \$596 | |
| | TOPR25LS | Blue Limestone | | 25 mm | Rectangle | Single, Center | 3-hole | \$596 | |
| | TOPO25MG | Grey Marble | | 18 mm | Oval | Single, Center | 3-hole | \$534 | |
| | TOPR25MG | Grey Marble | | 18 mm | Rectangle | Single, Center | 3-hole | \$534 | |
| | TOPO25WC | White Carrara Marble | | 25 mm | Oval | Single, Center | 3-hole | \$725 | |
| | TOPR25WC | White Carrara Marble | | 25 mm | Rectangle | Single, Center | 3-hole | \$725 | |
| | TOPO25AS* | ENGINEERED | | Arctic Stone | 25 mm | Oval | Single, Center | 3-hole | \$434 |
| | TOPO25BO* | | | Boulder | 25 mm | Oval | Single, Center | 3-hole | \$434 |
| | TOPR25BO* | | Boulder | 25 mm | Rectangle | Single, Center | 3-hole | \$474 | |
| | TOPR25RE | | White Stone Resin | 64 mm | Rectangle | Single, Center, Integrated | 3-hole | \$482 | |
| TOPO25SG* | Steel Grey | | 25 mm | Oval | Single, Center | 3-hole | \$434 | | |
| TOPR25SG* | Steel Grey | | 25 mm | Rectangle | Single, Center | 3-hole | \$474 | | |

Coordinating sidesplashes, bowls (page 29), and mirrors (pages 30-36) are available.

4" tall backsplash included with each top except White Stone Resin

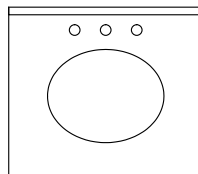

TOPO25xx

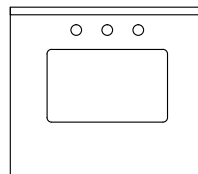

TOPR25xx

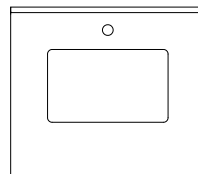

TOPR25WQ-1

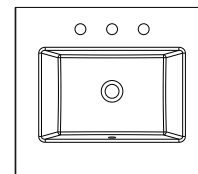

TOPR25RE
(integrated bowl)

31" TOPS

| Size | Item # | Material | Thickness | Bowl Shape | Bowl Layout | Faucet Layout | List Price | |
|------|--------------|---------------|-------------------------|------------|-------------|----------------------------|------------|---------|
| 31" | TOPO31BQ* | QUARTZ | Calacatta Black Quartz | 18 mm | Oval | Single, Center | 3-hole | \$1,544 |
| | TOPR31BQ* | | Calacatta Black Quartz | 18 mm | Rectangle | Single, Center | 3-hole | \$1,544 |
| | TOPO31CQ | | Calacatta Vienna Quartz | 18 mm | Oval | Single, Center | 3-hole | \$1,488 |
| | TOPR31CQ | | Calacatta Vienna Quartz | 18 mm | Rectangle | Single, Center | 3-hole | \$1,488 |
| | TOPO31GQ | | Grey Quartz | 18 mm | Oval | Single, Center | 3-hole | \$725 |
| | TOPR31GQ | | Grey Quartz | 18 mm | Rectangle | Single, Center | 3-hole | \$725 |
| | TOPR31WQ | | White Quartz | 18 mm | Rectangle | Single, Center | 3-hole | \$870 |
| | TOPR31WQ-1 | | White Quartz | 18 mm | Rectangle | Single, Center | 1-hole | \$870 |
| | TOPO31BG | NATURAL STONE | Black Granite | 25 mm | Oval | Single, Center | 3-hole | \$725 |
| | TOPR31BG | | Black Granite | 25 mm | Rectangle | Single, Center | 3-hole | \$725 |
| | TOPO31LS | | Blue Limestone | 25 mm | Oval | Single, Center | 3-hole | \$725 |
| | TOPR31LS | | Blue Limestone | 25 mm | Rectangle | Single, Center | 3-hole | \$725 |
| | TOPO31MG | | Grey Marble | 18 mm | Oval | Single, Center | 3-hole | \$654 |
| | TOPR31MG | | Grey Marble | 18 mm | Rectangle | Single, Center | 3-hole | \$654 |
| | TOPO31WC | | White Carrara Marble | 25 mm | Oval | Single, Center | 3-hole | \$828 |
| | TOPR31WC | | White Carrara Marble | 25 mm | Rectangle | Single, Center | 3-hole | \$828 |
| | TOPO31AS* | ENGINEERED | Arctic Stone | 25 mm | Oval | Single, Center | 3-hole | \$566 |
| | TOPR31AS* | | Arctic Stone | 25 mm | Rectangle | Single, Center | 3-hole | \$617 |
| | TOPO31BO* | | Boulder | 25 mm | Oval | Single, Center | 3-hole | \$566 |
| | TOPR31BO* | | Boulder | 25 mm | Rectangle | Single, Center | 3-hole | \$617 |
| | TOPR31RE | | White Stone Resin | 64 mm | Rectangle | Single, Center, Integrated | 3-hole | \$580 |
| | TOPR3119RE-1 | | White Stone Resin | 64 mm | Rectangle | Single, Center, Integrated | 1-hole | \$410 |
| | TOPO31SG* | | Steel Grey | 25 mm | Oval | Single, Center | 3-hole | \$566 |
| | TOPR31SG* | | Steel Grey | 25 mm | Rectangle | Single, Center | 3-hole | \$617 |

Coordinating sidesplashes, bowls (page 29), and mirrors (pages 30-36) are available.

4" tall backsplash included with each top except White Stone Resin

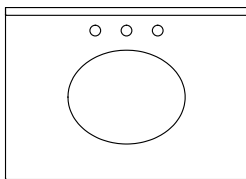

TOPO31xx

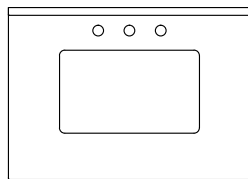

TOPR31xx

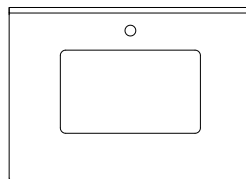

TOPR31WQ-1

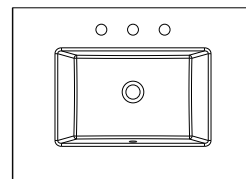

TOPR31RE
(integrated bowl)

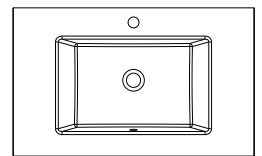

TOPR3119RE-1
(integrated bowl)

37" TOPS - OVAL BOWL

| Size | Item # | Material | Thickness | Bowl Shape | Bowl Layout | List Price | | |
|------------------|------------------|---------------|-------------------------|--------------|---------------|----------------|----------------|-------|
| 37" | TOPO37BQ* | QUARTZ | Calacatta Black Quartz | 18 mm | Oval | Single, Center | \$1,816 | |
| | TOPO37BQAST* | | Calacatta Black Quartz | 18 mm | Oval | Single, Right | \$1,816 | |
| | TOPO37BQCAD-ADD* | | Calacatta Black Quartz | 18 mm | Oval | Single, Left | \$1,816 | |
| | TOPO37CQ | | Calacatta Vienna Quartz | 18 mm | Oval | Single, Center | \$1,749 | |
| | TOPO37CQAST* | | Calacatta Vienna Quartz | 18 mm | Oval | Single, Right | \$1,749 | |
| | TOPO37CQCAD-ADD | | Calacatta Vienna Quartz | 18 mm | Oval | Single, Left | \$1,749 | |
| | TOPO37GQ | | Grey Quartz | 18 mm | Oval | Single, Center | \$828 | |
| | TOPO37GQAST* | | Grey Quartz | 18 mm | Oval | Single, Right | \$828 | |
| | TOPO37GQCAD-ADD | | Grey Quartz | 18 mm | Oval | Single, Left | \$828 | |
| | TOPO37BG | NATURAL STONE | Black Granite | 25 mm | Oval | Single, Center | \$933 | |
| | TOPO37BGAST* | | Black Granite | 25 mm | Oval | Single, Right | \$933 | |
| | TOPO37BGCAD-ADD | | Black Granite | 25 mm | Oval | Single, Left | \$933 | |
| | TOPO37LS | | Blue Limestone | 25 mm | Oval | Single, Center | \$933 | |
| | TOPO37LSAST* | | Blue Limestone | 25 mm | Oval | Single, Right | \$933 | |
| | TOPO37LSCAD-ADD | | Blue Limestone | 25 mm | Oval | Single, Left | \$933 | |
| | TOPO37MG | | Grey Marble | 18 mm | Oval | Single, Center | \$839 | |
| | TOPO37MGAST | | Grey Marble | 18 mm | Oval | Single, Right | \$839 | |
| | TOPO37MGCAD-ADD | | Grey Marble | 18 mm | Oval | Single, Left | \$839 | |
| | TOPO37WC | | White Carrara Marble | 25 mm | Oval | Single, Center | \$985 | |
| | TOPO37WCAST* | | White Carrara Marble | 25 mm | Oval | Single, Right | \$985 | |
| | TOPO37WCCAD-ADD | | White Carrara Marble | 25 mm | Oval | Single, Left | \$985 | |
| | TOPO37AS* | | CULTURED MARBLE | Arctic Stone | 25 mm | Oval | Single, Center | \$611 |
| | TOPO37ASAST* | | | Arctic Stone | 25 mm | Oval | Single, Right | \$611 |
| | TOPO37ASCAD-ADD* | | | Arctic Stone | 25 mm | Oval | Single, Left | \$611 |
| | TOPO37BO* | Boulder | | 25 mm | Oval | Single, Center | \$611 | |
| | TOPO37BOAST* | Boulder | | 25 mm | Oval | Single, Right | \$611 | |
| | TOPO37BOCAD-ADD* | Boulder | | 25 mm | Oval | Single, Left | \$611 | |
| | TOPO37SG* | Steel Grey | | 25 mm | Oval | Single, Center | \$611 | |
| TOPO37SGAST* | Steel Grey | 25 mm | | Oval | Single, Right | \$611 | | |
| TOPO37SGCAD-ADD* | Steel Grey | 25 mm | | Oval | Single, Left | \$611 | | |

Coordinating sidesplashes, bowls (page 29), and mirrors (pages 30-36) are available.

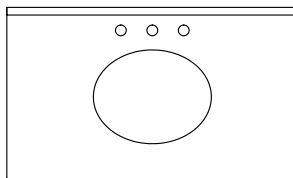

TOPO37xx

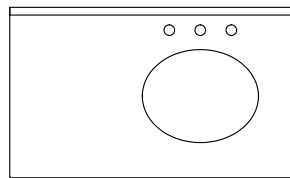

TOPO37xxAST

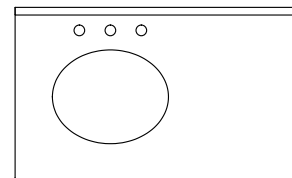

TOPO37xxCAD-ADD

Effective 1/1/2024

37" TOPS - RECTANGLE BOWL

| Size | Item # | Material | Thickness | Bowl Shape | Bowl Layout | Faucet Layout | List Price | |
|------|------------------|----------------------|-------------------------|---------------|-------------|----------------------------|----------------|---------|
| 37" | TOPR37BQ* | QUARTZ | Calacatta Black Quartz | 18 mm | Rectangle | Single, Center | 3-hole | \$1,816 |
| | TOPR37BQAST* | | Calacatta Black Quartz | 18 mm | Rectangle | Single, Right | 3-hole | \$1,816 |
| | TOPR37BQCAD-ADD* | | Calacatta Black Quartz | 18 mm | Rectangle | Single, Left | 3-hole | \$1,816 |
| | TOPR37CQ | | Calacatta Vienna Quartz | 18 mm | Rectangle | Single, Center | 3-hole | \$1,749 |
| | TOPR37CQAST | | Calacatta Vienna Quartz | 18 mm | Rectangle | Single, Right | 3-hole | \$1,749 |
| | TOPR37CQCAD-ADD | | Calacatta Vienna Quartz | 18 mm | Rectangle | Single, Left | 3-hole | \$1,749 |
| | TOPR37GQ | | Grey Quartz | 18 mm | Rectangle | Single, Center | 3-hole | \$828 |
| | TOPR37GQAST* | | Grey Quartz | 18 mm | Rectangle | Single, Right | 3-hole | \$828 |
| | TOPR37GQCAD-ADD | | Grey Quartz | 18 mm | Rectangle | Single, Left | 3-hole | \$828 |
| | TOPR37WQ | | White Quartz | 18 mm | Rectangle | Single, Center | 3-hole | \$995 |
| | TOPR37WQCAD-ADD | | White Quartz | 18 mm | Rectangle | Single, Left | 3-hole | \$995 |
| | TOPR37BG | | NATURAL STONE | Black Granite | 25 mm | Rectangle | Single, Center | 3-hole |
| | TOPR37BGAST* | Black Granite | | 25 mm | Rectangle | Single, Right | 3-hole | \$933 |
| | TOPR37BGCAD-ADD | Black Granite | | 25 mm | Rectangle | Single, Left | 3-hole | \$933 |
| | TOPR37LS | Blue Limestone | | 25 mm | Rectangle | Single, Center | 3-hole | \$933 |
| | TOPR37LSAST* | Blue Limestone | | 25 mm | Rectangle | Single, Right | 3-hole | \$933 |
| | TOPR37LSCAD-ADD | Blue Limestone | | 25 mm | Rectangle | Single, Left | 3-hole | \$933 |
| | TOPR37MG | Grey Marble | | 18 mm | Rectangle | Single, Center | 3-hole | \$839 |
| | TOPR37MGAST* | Grey Marble | | 18 mm | Rectangle | Single, Right | 3-hole | \$839 |
| | TOPR37MGCAD-ADD | Grey Marble | | 18 mm | Rectangle | Single, Left | 3-hole | \$839 |
| | TOPR37WC | White Carrara Marble | | 25 mm | Rectangle | Single, Center | 3-hole | \$985 |
| | TOPR37WCAST* | White Carrara Marble | | 25 mm | Rectangle | Single, Right | 3-hole | \$985 |
| | TOPR37WCCAD-ADD | White Carrara Marble | | 25 mm | Rectangle | Single, Left | 3-hole | \$985 |
| | TOPR37AS* | ENGINEERED | Arctic Stone | 25 mm | Rectangle | Single, Center | 3-hole | \$666 |
| | TOPR37ASAST* | | Arctic Stone | 25 mm | Rectangle | Single, Right | 3-hole | \$666 |
| | TOPR37ASCAD-ADD* | | Arctic Stone | 25 mm | Rectangle | Single, Left | 3-hole | \$666 |
| | TOPR37BO* | | Boulder | 25 mm | Rectangle | Single, Center | 3-hole | \$666 |
| | TOPR37BOAST* | | Boulder | 25 mm | Rectangle | Single, Right | 3-hole | \$666 |
| | TOPR37BOCAD-ADD* | | Boulder | 25 mm | Rectangle | Single, Left | 3-hole | \$666 |
| | TOPR37RE | | White Stone Resin | 64 mm | Rectangle | Single, Center, Integrated | 3-hole | \$624 |
| | TOPR37RECAD-ADD | | White Stone Resin | 64 mm | Rectangle | Single, Left, Integrated | 3-hole | \$624 |
| | TOPR3719RE-1 | | White Stone Resin | 64 mm | Rectangle | Single, Center, Integrated | 1-hole | \$624 |
| | TOPR37SG* | | Steel Grey | 25 mm | Rectangle | Single, Center | 3-hole | \$666 |
| | TOPR37SGAST* | | Steel Grey | 25 mm | Rectangle | Single, Right | 3-hole | \$666 |
| | TOPR37SGCAD-ADD* | | Steel Grey | 25 mm | Rectangle | Single, Left | 3-hole | \$666 |

Coordinating sidesplashes, bowls (page 29), and mirrors (pages 30-36) are available.

4" tall backsplash included with each top except White Stone Resin

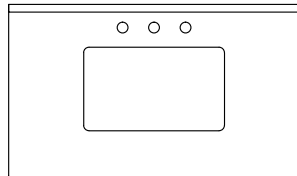

TOPR37xx

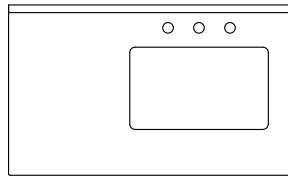

TOPR37xxAST

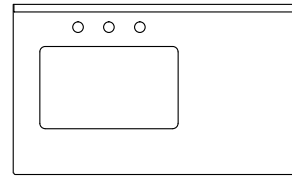

TOPR37xxCAD-ADD

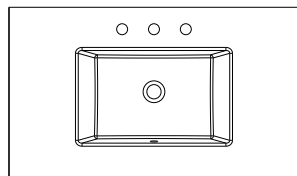

TOPR37RE
(integrated bowl)

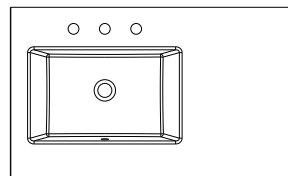

TOPR37RECAD-ADD
(integrated bowl)

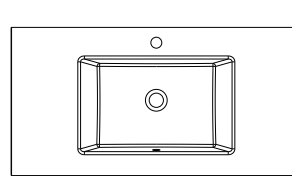

TOPR3719RE-1
(integrated bowl)

43" TOPS

| Size | Item # | Material | Thickness | Bowl Shape | Bowl Layout | List Price | |
|------|---------------|---------------|--------------------------------|------------|--------------|--------------------------|---------|
| 43" | TOPO43BQ-LFT* | QUARTZ | Calacatta Black Quartz | 18 mm | Oval | Single, Left | \$2,000 |
| | TOPR43BQ-LFT* | | Calacatta Black Quartz | 18 mm | Rectangle | Single, Left | \$2,000 |
| | TOPO43CQ-LFT | | Calacatta Vienna Quartz | 18 mm | Oval | Single, Left | \$2,000 |
| | TOPR43CQ-LFT | | Calacatta Vienna Quartz | 18 mm | Rectangle | Single, Left | \$2,000 |
| | TOPO43GQ-LFT | | Grey Quartz | 18 mm | Oval | Single, Left | \$976 |
| | TOPR43GQ-LFT | | Grey Quartz | 18 mm | Rectangle | Single, Left | \$976 |
| | TOPR43WQ-LFT | Grey Quartz | 18 mm | Rectangle | Single, Left | \$1,172 | |
| | TOPO43BG-LFT | NATURAL STONE | Black Granite | 25 mm | Oval | Single, Left | \$1,071 |
| | TOPR43BG-LFT | | Black Granite | 25 mm | Rectangle | Single, Left | \$1,071 |
| | TOPO43LS-LFT | | Blue Limestone | 25 mm | Oval | Single, Left | \$1,003 |
| | TOPR43LS-LFT | | Blue Limestone | 25 mm | Rectangle | Single, Left | \$1,003 |
| | TOPO43MG-LFT | | Grey Marble | 18 mm | Oval | Single, Left | \$935 |
| | TOPR43MG-LFT | | Grey Marble | 18 mm | Rectangle | Single, Left | \$935 |
| | TOPO43WC-LFT | | White Carrara Marble | 25 mm | Oval | Single, Left | \$1,157 |
| | TOPR43WC-LFT | | White Carrara Marble | 25 mm | Rectangle | Single, Left | \$1,157 |
| | TOPR43RE-LFT | | White Stone Resin (Engineered) | 64 mm | Rectangle | Single, Left, Integrated | \$785 |

Coordinating sidesplashes, bowls (page 29), and mirrors (pages 30-36) are available.

4" tall backsplash included with each top except White Stone Resin

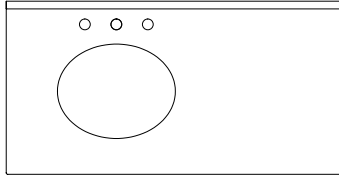

TOPO43xx-LFT

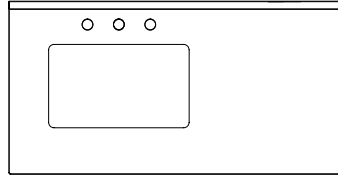

TOPR43xx-LFT

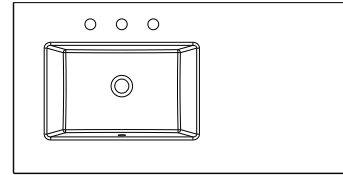

TOPR43RE-LFT
(integrated bowl)

49" TOPS

| Size | Item # | Material | Thickness | Bowl Shape | Bowl Layout | Faucet Layout | List Price | |
|-----------|--------------|----------------------|-------------------------|------------|----------------|----------------------------|------------|---------|
| 49" | TOPO49BQ* | QUARTZ | Calacatta Black Quartz | 18 mm | Oval | Single, Center | 3-hole | \$2,359 |
| | TOPR49BQ* | | Calacatta Black Quartz | 18 mm | Rectangle | Single, Center | 3-hole | \$2,359 |
| | TOPO49CQ | | Calacatta Vienna Quartz | 18 mm | Oval | Single, Center | 3-hole | \$2,272 |
| | TOPR49CQ | | Calacatta Vienna Quartz | 18 mm | Rectangle | Single, Center | 3-hole | \$2,272 |
| | TOPO49GQ | | Grey Quartz | 18 mm | Oval | Single, Center | 3-hole | \$1,036 |
| | TOPR49GQ | | Grey Quartz | 18 mm | Rectangle | Single, Center | 3-hole | \$1,036 |
| | TOPR49WQ | | White Quartz | 18 mm | Rectangle | Single, Center | 3-hole | \$1,244 |
| | TOPO49BG | NATURAL STONE | Black Granite | 25 mm | Oval | Single, Center | 3-hole | \$1,192 |
| | TOPR49BG | | Black Granite | 25 mm | Rectangle | Single, Center | 3-hole | \$1,192 |
| | TOPO49LS | | Blue Limestone | 25 mm | Oval | Single, Center | 3-hole | \$1,192 |
| | TOPR49LS | | Blue Limestone | 25 mm | Rectangle | Single, Center | 3-hole | \$1,192 |
| | TOPO49MG | | Grey Marble | 18 mm | Oval | Single, Center | 3-hole | \$1,072 |
| | TOPR49MG | | Grey Marble | 18 mm | Rectangle | Single, Center | 3-hole | \$1,072 |
| | TOPO49WC | | White Carrara Marble | 25 mm | Oval | Single, Center | 3-hole | \$1,367 |
| | TOPR49WC | White Carrara Marble | 25 mm | Rectangle | Single, Center | 3-hole | \$1,367 | |
| | TOPR49AS* | ENGINEERED | Arctic Stone | 25 mm | Rectangle | Single, Center | 3-hole | \$1,007 |
| | TOPO49BO* | | Boulder | 25 mm | Oval | Single, Center | 3-hole | \$923 |
| | TOPR49BO* | | Boulder | 25 mm | Rectangle | Single, Center | 3-hole | \$1,007 |
| | TOPR49RE | | White Stone Resin | 64 mm | Rectangle | Single, Center, Integrated | 3-hole | \$945 |
| | TOPR4919RE-1 | | White Stone Resin | 64 mm | Rectangle | Single, Center, Integrated | 1-hole | \$545 |
| TOPO49SG* | Steel Grey | | 25 mm | Oval | Single, Center | 3-hole | \$923 | |
| TOPR49SG* | Steel Grey | | 25 mm | Rectangle | Single, Center | 3-hole | \$1,007 | |

Coordinating sidesplashes, bowls (page 29), and mirrors (pages 30-36) are available.

4" tall backsplash included with each top except White Stone Resin

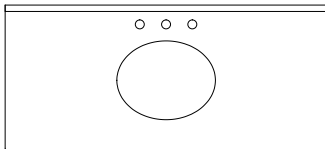

TOPO49xx

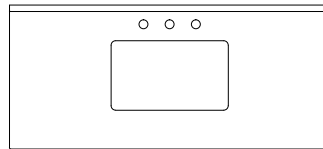

TOPR49xx

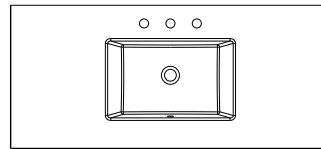

TOPR49RE (integrated bowl)

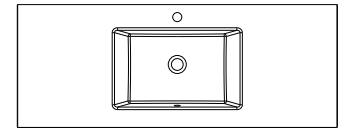

TOPR4919RE-1 (integrated bowl)

61" TOPS - SINGLE BOWL

| Size | Item # | Material | Thickness | Bowl Shape | Bowl Layout | List Price | |
|------------|------------|----------------------|-------------------------|------------|----------------|----------------------------|---------|
| 61" | TOPO61SBQ* | QUARTZ | Calacatta Black Quartz | 18 mm | Oval | Single, Center | \$2,903 |
| | TOPR61SBQ* | | Calacatta Black Quartz | 18 mm | Rectangle | Single, Center | \$2,903 |
| | TOPO61SCQ | | Calacatta Vienna Quartz | 18 mm | Oval | Single, Center | \$2,793 |
| | TOPR61SCQ | | Calacatta Vienna Quartz | 18 mm | Rectangle | Single, Center | \$2,793 |
| | TOPO61SGQ | | Grey Quartz | 18 mm | Oval | Single, Center | \$1,558 |
| | TOPR61SGQ | | Grey Quartz | 18 mm | Rectangle | Single, Center | \$1,558 |
| | TOPR61SWQ | | White Quartz | 18 mm | Rectangle | Single, Center | \$1,870 |
| | TOPO61SBG | NATURAL STONE | Black Granite | 25 mm | Oval | Single, Center | \$1,731 |
| | TOPR61SBG | | Black Granite | 25 mm | Rectangle | Single, Center | \$1,731 |
| | TOPO61SLS | | Blue Limestone | 25 mm | Oval | Single, Center | \$1,731 |
| | TOPR61SLS | | Blue Limestone | 25 mm | Rectangle | Single, Center | \$1,731 |
| | TOPO61SMG | | Grey Marble | 18 mm | Oval | Single, Center | \$1,558 |
| | TOPR61SMG | | Grey Marble | 18 mm | Rectangle | Single, Center | \$1,558 |
| | TOPO61SWC | | White Carrara Marble | 25 mm | Oval | Single, Center | \$2,050 |
| | TOPR61SWC | White Carrara Marble | 25 mm | Rectangle | Single, Center | \$2,050 | |
| | TOPO61SAS* | ENGINEERED | Arctic Stone | 25 mm | Oval | Single, Center | \$1,171 |
| | TOPR61SAS* | | Arctic Stone | 25 mm | Rectangle | Single, Center | \$1,278 |
| | TOPO61SBO* | | Boulder | 25 mm | Oval | Single, Center | \$1,171 |
| | TOPR61SBO* | | Boulder | 25 mm | Rectangle | Single, Center | \$1,278 |
| | TOPR61SRE | | White Stone Resin | 64 mm | Rectangle | Single, Center, Integrated | \$1,363 |
| TOPO61SSG* | Steel Grey | | 25 mm | Oval | Single, Center | \$1,171 | |
| TOPR61SSG* | Steel Grey | | 25 mm | Rectangle | Single, Center | \$1,278 | |

Coordinating sidesplashes, bowls (page 29), and mirrors (pages 30-36) are available.

4" tall backsplash included with each top except White Stone Resin

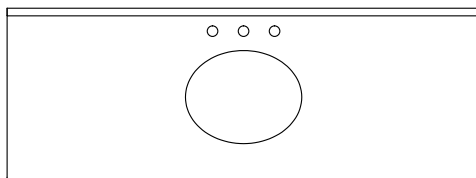

TOPO61Sxx

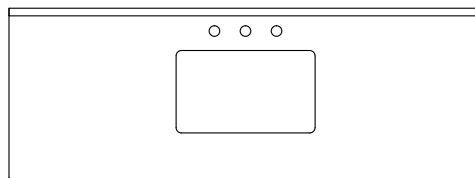

TOPR61Sxx

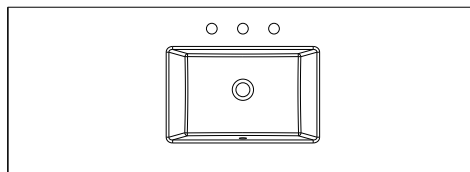

TOPR61SRE
(integrated bowl)

61" TOPS - DOUBLE BOWL

| Size | Item # | Material | Thickness | Bowl Shape | Bowl Layout | List Price | |
|-----------|------------|----------------------|-------------------------|----------------------|----------------------|----------------------------------|----------------------|
| 61" | TOPO61BQ* | QUARTZ | Calacatta Black Quartz | 18 mm | Oval | Double, Left & Right | \$3,044 |
| | TOPR61BQ* | | Calacatta Black Quartz | 18 mm | Rectangle | Double, Left & Right | \$3,044 |
| | TOPO61CQ | | Calacatta Vienna Quartz | 18 mm | Oval | Double, Left & Right | \$2,933 |
| | TOPR61CQ | | Calacatta Vienna Quartz | 18 mm | Rectangle | Double, Left & Right | \$2,933 |
| | TOPO61GQ | | Grey Quartz | 18 mm | Oval | Double, Left & Right | \$1,558 |
| | TOPR61GQ | | Grey Quartz | 18 mm | Rectangle | Double, Left & Right | \$1,558 |
| | TOPR61WQ | | White Quartz | 18 mm | Rectangle | Double, Left & Right | \$1,870 |
| | TOPO61BG | | NATURAL STONE | Black Granite | 25 mm | Oval | Double, Left & Right |
| | TOPR61BG | Black Granite | | 25 mm | Rectangle | Double, Left & Right | \$1,731 |
| | TOPO61LS | Blue Limestone | | 25 mm | Oval | Double, Left & Right | \$1,731 |
| | TOPR61LS | Blue Limestone | | 25 mm | Rectangle | Double, Left & Right | \$1,731 |
| | TOPO61MG | Grey Marble | | 18 mm | Oval | Double, Left & Right | \$1,558 |
| | TOPR61MG | Grey Marble | | 18 mm | Rectangle | Double, Left & Right | \$1,558 |
| | TOPO61WC | White Carrara Marble | | 25 mm | Oval | Double, Left & Right | \$2,050 |
| | TOPR61WC | White Carrara Marble | | 25 mm | Rectangle | Double, Left & Right | \$2,050 |
| | TOPO61AS* | ENGINEERED | Arctic Stone | 25 mm | Oval | Double, Left & Right | \$1,330 |
| | TOPR61AS* | | Arctic Stone | 25 mm | Rectangle | Double, Left & Right | \$1,452 |
| | TOPO61BO* | | Boulder | 25 mm | Oval | Double, Left & Right | \$1,330 |
| | TOPR61BO* | | Boulder | 25 mm | Rectangle | Double, Left & Right | \$1,452 |
| | TOPR61RE | | White Stone Resin | 64 mm | Rectangle | Double, Left & Right, Integrated | \$1,363 |
| TOPO61SG* | Steel Grey | | 25 mm | Oval | Double, Left & Right | \$1,330 | |
| TOPR61SG* | Steel Grey | 25 mm | Rectangle | Double, Left & Right | \$1,452 | | |

Coordinating sidesplashes, bowls (page 29), and mirrors (pages 30-36) are available.

4" tall backsplash included with each top except White Stone Resin

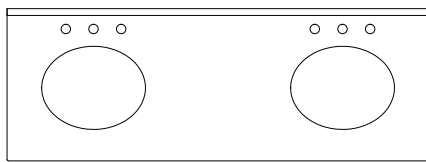

TOPO61xx

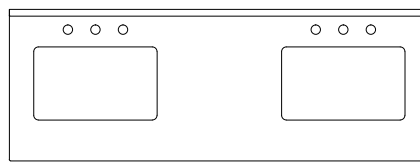

TOPR61xx

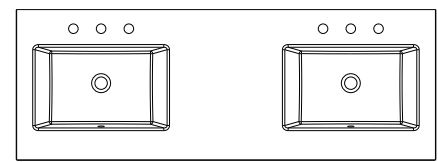

TOPR61RE (integrated bowl)

SIDESPLASHES

| Size | Item # | Material | Thickness | List Price | |
|------|--------------|---------------|-------------------------|------------|-------|
| 22" | SSPLASH21BQ* | QUARTZ | Calacatta Black Quartz | 18 mm | \$175 |
| | SSPLASH21CQ | | Calacatta Vienna Quartz | 18 mm | \$168 |
| | SSPLASH21GQ | | Grey Quartz | 18 mm | \$109 |
| | SSPLASH21WQ | | White Quartz | 18 mm | \$131 |
| | SSPLASH21BG | NATURAL STONE | Black Granite | 25 mm | \$141 |
| | SSPLASH21LS | | Blue Limestone | 25 mm | \$136 |
| | SSPLASH21MG | | Grey Marble | 18 mm | \$130 |
| | SSPLASH21WC | | White Carrara Marble | 25 mm | \$157 |
| | SSPLASH21BO* | | Boulder (Engineered) | 25 mm | \$86 |

BOWLS

| Item # | Material | Dimensions (Width X Height) | Bowl Shape | Compatibility | List Price |
|-------------|-----------|--------------------------------|------------|---|------------|
| VN2-OVAL-15 | Porcelain | 15" x 12" | Oval | All oval cutout tops | \$107 |
| VN2-RECT-16 | Porcelain | 15-1/2" x 9-3/8" | Rectangle | 25" rectangle cutout tops | \$126 |
| VN2-RECT-19 | Porcelain | 17-29/32" x 10-5/8" | Rectangle | 31", 37", 43", 49", & 61" rectangle cutout tops | \$126 |

VN2-OVAL-15

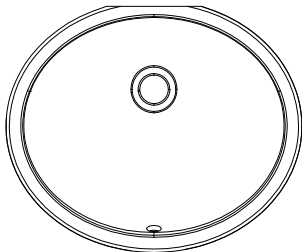

VN2-RECT-16

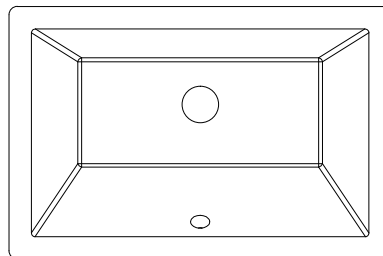

VN2-RECT-19

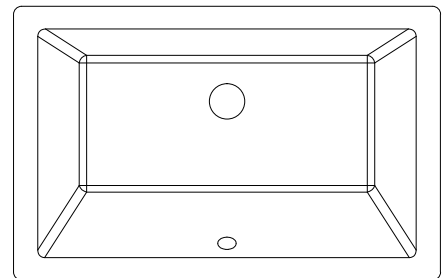

Prices are subject to change

16" WOOD FRAME MIRRORS

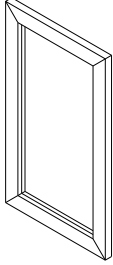
| Dimensions (width x height) | | Finish | | |
|---|-----------|---------------|---------------|---------------|
|  | 16" x 28" | Grey | White | Hale Blue |
| | | MIR2CAD-16-GR | MIR2CAD-16-WH | MIR2CAD-16-BL |
| | | \$229 | \$229 | \$229 |

20" WOOD FRAME MIRRORS

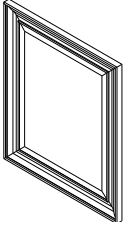
| Dimensions (width x height) | | Finish | | |
|--|-----------|----------------|----------------|----------------|
|  | 20" x 24" | Black | White | Hale Blue |
| | | MIR2DOU-20-BK* | MIR2DOU-20-WH* | MIR2DOU-20-BL* |
| | | \$291 | \$291 | \$291 |

22" WOOD FRAME MIRRORS

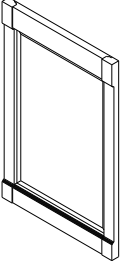
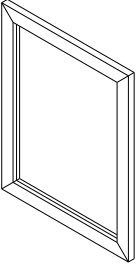
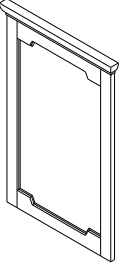
| Dimensions (width x height) | | Finish | | | | |
|---|-----------|---------------------|-----------------------|--------------------|--------------------|---------------------|
|  | 22" x 34" | Espresso | White | | | |
| | | MIR2AST-22-ES* | MIR2AST-22-WH* | | | |
| | | \$365 | \$365 | | | |
|  | 22" x 28" | Black | Grey | White | Hale Blue | Forest Green |
| | | MIR2CAD-22-BK | MIR2CAD-22-GR | MIR2CAD-22-WH | MIR2CAD-22-BL | MIR2CAD-22-GN |
| | | \$291 | \$291 | \$291 | \$291 | \$287 |
| | | Blue Steel | Weathered Grey | Dark Walnut | Natural Oak | |
| | | MIR2CAD-22-BS | MIR2CAD-22-WG | MIR2CAD-22-DW | MIR2CAD-22-NO | |
| | | \$291 | \$291 | \$291 | \$291 | |
|  | 22" x 34" | Chocolate | Grey | White | Hale Blue | Blue Steel |
| | | MIR2CHA-22-CH | MIR2CHA-22-GR | MIR2CHA-22-WH | MIR2CHA-22-BL | MIR2CHA-22-BS |
| | | \$370 | \$370 | \$370 | \$370 | \$370 |
| | | Forest Green | Black | | | |
| | | MIR2CHA-22-GN | MIR2CHA-22-BK | | | |
| | | \$370 | \$370 | | | |

24" WOOD FRAME MIRRORS

| Dimensions (width x height) | | Finish | | | | |
|--|-----------|-------------------|-----------------------|--------------------|--------------------|---------------------|
|  | 24" x 28" | Black | Grey | White | Hale Blue | Forest Green |
| | | MIR2ADL-24-BK* | MIR2ADL-24-GR* | MIR2ADL-24-WH* | MIR2ADL-24-BL* | MIR2ADL-24-GN* |
| | | \$410 | \$410 | \$410 | \$410 | \$410 |
|  | 24" x 28" | Black | Grey | White | Hale Blue | Forest Green |
| | | MIR2CAD-24-BK | MIR2CAD-24-GR | MIR2CAD-24-WH | MIR2CAD-24-BL | MIR2CAD-24-GN |
| | | \$318 | \$318 | \$318 | \$318 | \$318 |
| | | Blue Steel | Weathered Grey | Dark Walnut | Natural Oak | |
| | | MIR2CAD-24-BS | MIR2CAD-24-WG | MIR2CAD-24-DW | MIR2CAD-24-NO | |
| | | \$318 | \$318 | \$318 | \$318 | |

28" WOOD FRAME MIRRORS

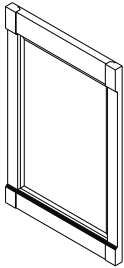
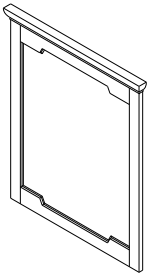
| Dimensions (width x height) | | Finish | | | | |
|--|-----------|------------------|-------------------|---------------|------------------|---------------------|
|  | 28" x 34" | Espresso | White | | | |
| | | MIR2AST-28-ES* | MIR2AST-28-WH* | | | |
| | | \$416 | \$416 | | | |
|  | 28" x 34" | Chocolate | Grey | White | Hale Blue | Forest Green |
| | | MIR2CHA-28-CH | MIR2CHA-28-GR | MIR2CHA-28-WH | MIR2CHA-28-BL | MIR2CHA-28-GN |
| | | \$460 | \$460 | \$460 | \$460 | \$460 |
| | | Black | Blue Steel | | | |
| | | MIR2CHA-28-BK | MIR2CHA-28-BS | | | |
| | | \$460 | \$460 | | | |

33" WOOD FRAME MIRRORS

| | Dimensions (width x height) | Finish | | | | |
|---|--------------------------------|-------------------|-----------------------|--------------------|--------------------|---------------|
| | | Black | Grey | White | Hale Blue | Forest Green |
|  | 33" x 28" | MIR2CAD-33-BK | MIR2CAD-33-GR | MIR2CAD-33-WH | MIR2CAD-33-BL | MIR2CAD-33-GN |
| | | \$370 | \$370 | \$370 | \$370 | \$370 |
| | | Blue Steel | Weathered Grey | Dark Walnut | Natural Oak | |
| | | MIR2CAD-33-BS | MIR2CAD-33-WG | MIR2CAD-33-DW | MIR2CAD-33-NO | |
| | | \$370 | \$370 | \$370 | \$370 | |
| | | | | | | |

40" WOOD FRAME MIRRORS

| | Dimensions (width x height) | Finish | | | | |
|---|--------------------------------|-------------------|---------------|---------------|---------------|---------------|
| | | Chocolate | Grey | White | Hale Blue | Black |
|  | 40" x 34" | MIR2CHA-40-CH | MIR2CHA-40-GR | MIR2CHA-40-WH | MIR2CHA-40-BL | MIR2CHA-40-BK |
| | | \$532 | \$532 | \$532 | \$532 | \$532 |
| | | Blue Steel | | | | |
| | | MIR2CHA-40-BS | | | | |
| | | \$532 | | | | |

42" WOOD FRAME MIRRORS

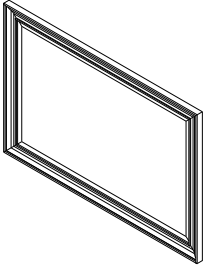
| Dimensions (width x height) | | Finish | | | |
|---|-----------|----------------|----------------|----------------|----------------|
|  | 42" x 28" | Black | White | Hale Blue | Forest Green |
| | | MIR2DOU-42-BK* | MIR2DOU-42-WH* | MIR2DOU-42-BL* | MIR2DOU-42-GN* |
| | | \$555 | \$555 | \$555 | \$555 |

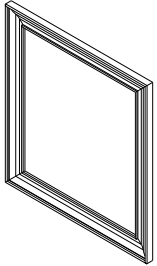

ADDITIONAL WOOD FRAME MIRRORS

| Dimensions (width x height) | | Finish | | | | |
|--|-----------|----------------|----------------|----------------|----------------|----------------|
|  | 22" x 24" | Black | Grey | White | Hale Blue | Forest Green |
| | | MIR2JEN-22-BK* | MIR2JEN-22-GR* | MIR2JEN-22-WH* | MIR2JEN-22-BL* | MIR2JEN-22-GN* |
| | | \$365 | \$365 | \$365 | \$365 | \$365 |

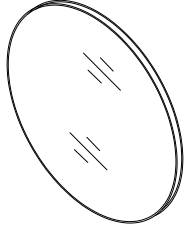
ROUND METAL FRAME MIRRORS

| Dimensions (circumference) | | Finish | | | |
|---|-----|----------------|----------------|-----------------|----------------|
|  | 30" | Brushed Gold | Matte Black | Satin Bronze | Satin Nickel |
| | | VMIR-METC-30BG | VMIR-METC-30MB | VMIR-METC-30SBZ | VMIR-METC-30SN |
| | | \$346 | \$346 | \$346 | \$346 |

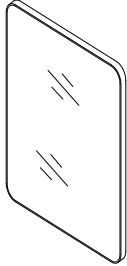
RECTANGLE METAL FRAME MIRRORS

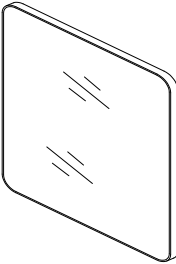
| Dimensions (width x height) | | Finish | | | |
|---|-----------|---------------------|--------------------|---------------------|---------------------|
|  | 22" x 30" | Brushed Gold | Matte Black | Satin Bronze | Satin Nickel |
| | | VMIR-METR-22BG | VMIR-METR-22MB | VMIR-METR-22SBZ | VMIR-METR-22SN |
| | | \$313 | \$313 | \$313 | \$313 |
|  | 24" x 30" | Brushed Gold | Matte Black | Satin Bronze | Satin Nickel |
| | | VMIR-METR-24BG | VMIR-METR-24MB | VMIR-METR-24SBZ | VMIR-METR-24SN |
| | | \$338 | \$338 | \$338 | \$338 |
|  | 33" x 28" | Brushed Gold | Matte Black | Satin Bronze | Satin Nickel |
| | | VMIR-METR-33BG | VMIR-METR-33MB | VMIR-METR-33SBZ | VMIR-METR-33SN |
| | | \$383 | \$383 | \$383 | \$383 |

ORDERING

- Website: www.HardwareResources.com
- Phone: (800) 463-0660
- Fax: (318) 742-9513
- Email: CustomerService@HardwareResources.com
- Mail: 4319 Marlena Street, Bossier City, LA 71111
- Customer Service is available from 7:00 am until 6:00 pm Central Time
- \$25 order minimum unless purchasing items as part of our Preferred program
- Your Will Call order will be ready for pickup two hours after you have received your order confirmation email. Will Call orders will be available for pickup between the hours of 8 am and 4 pm local warehouse time. Should you have any questions about picking up your order or need to have the order modified in any way, contact your Customer Service Representative.

The Hardware Resources website allows you to place an order, track parcel shipments, download price lists, view open invoices, add additional web site users, and offers many other features.

RETURNS

All requests for returns must be made within 60 days of invoice date. Returns are subject to a 20% restocking fee unless the return is due to Hardware Resources' error or a quality issue.

To request a Return Goods Authorization contact Customer Service.

- Phone: (800) 463-0660
- Fax: (318) 742-9513
- Email: ReturnRequest@HardwareResources.com
- Include the item number, quantity and reason for return when requesting an RGA

Items should be in original packaging and shipped with care to avoid damage. Items received damaged may not be credited.

In the event that the return is due to an error by Hardware Resources a return shipping label will be provided. Otherwise, shipments are the Customer's responsibility and should be via a method which allows shipment tracking and proof of delivery.

MINIMUM SELLING PRICE (MSP) POLICY

Hardware Resources has a strict internet MAP (Minimum Advertised Price) Policy. Our policy is a maximum 10% discount off of our current List Price across all Hardware Resources, Jeffrey Alexander, and Elements products for sale on the internet.

The only exception to the MAP policy is for products Hardware Resources has designated on our HardwareResources.com website as Discontinued.

Hardware Resources is committed to proactively seeking out, finding, and dealing with Internet MAP violations during and outside of regular business hours. We strive to find and fix MAP violations before we hear a complaint from a Customer. Policy violations result in suspensions and customer terminations, and we do several such terminations each year.

Log into your account on www.HardwareResources.com for a more detailed listing of our Policies, Procedures, and Warranty information.